

About us

關於我們

With Fine Packaging Comes Assurance

面面俱到的包覆 時時刻刻的安心

Yun-Lun Packaging Materials Co. Ltd. specializes in the R&D and manufacture of cushioning foam materials. Since its establishment in 1995, Yun-Lun has sought to "lead innovation in EPE application technology and create a sustainable culture for the packaging material industry". To address the introduction of new recyclable and environmentally friendly materials, Yun-Lun continuously engages in the R&D of diverse cushioning and packaging material applications, safeguarding our clients' products while giving consumers the opportunity to partake in green operations.

Cushioning and packaging materials should be light, low-temperature resistant, insulating, sound-absorbing, moisture resistant, shock-absorbing, etc., as well ideal for protective cladding, thereby ensuring sound delivery and that the products remain in normal working conditions. A whole variety of materials are used as cushioning and packaging materials, including EPE, EVA, IXPE, XPE, PS, PP, etc. Yun-Lun can also engage in the development of new materials according to our clients' needs.

允綸包裝材料股份有限公司是專業於緩衝發泡材料多元應用的研發製造商，自1995年成立以來，即秉持「領導EPE應用技術革新，創造包材永續新文化」的願景，因應可回收環保材料的推陳出新，持續研發緩衝包材的多元應用，妥善保護客戶商品，讓人們的每一次消費都能輕鬆落實綠色行動。

緩衝包材具備質輕、耐寒、保溫、吸音、防潮、吸震等特色，適合用於包覆穩固產品運送或確保產品功能正常發揮，材質多元包含EPE、EVA、IXPE、XPE、PS、PP等，允綸亦可依據客戶需求配合開發新興材質。

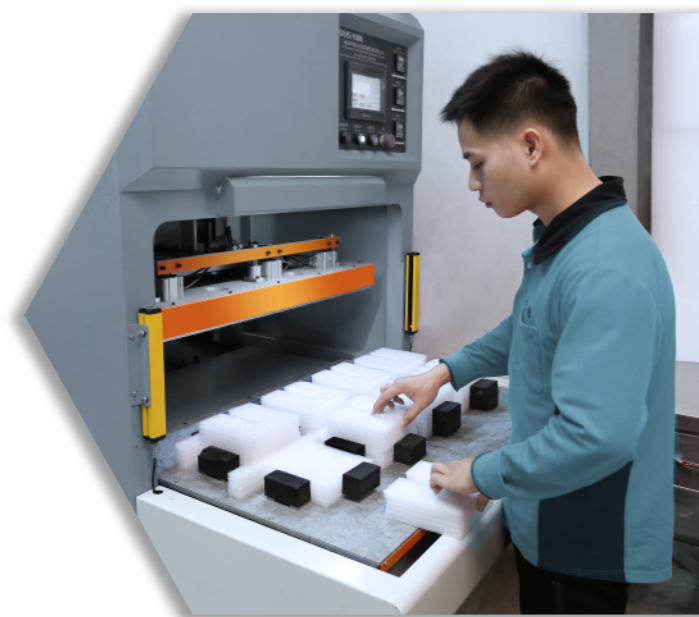

www.yunlun.com.tw



允綸包裝材料
YUN-LUN PACKAGING
MATERIALS

Elevating The Value
Of Our Clients' Brands
Through Fine Packaging
And Premium Quality Services

堅守高品質
以面面俱到的包覆
為客戶提升品牌價值

DESIGNED BY POLARIS 2020.02 / +886-4-24517070



允綸包裝材料股份有限公司
YUN-LUN PACKAGING MATERIALS CO., LTD.



439012 台中市大安區東安里中山南路86號
No. 86, Zhongshan S. Rd.,
Da'an Dist., Taichung City 439012, Taiwan(R.O.C.)
☎ 886-4-26713509 ☎ 886-4-26711509
✉ yunlun.com@msa.hinet.net
統一編號 89671451

PASSION
IN **PACKAGING**

緩衝發泡材料多元應用的研發製造商

正確設計 Optimal Design







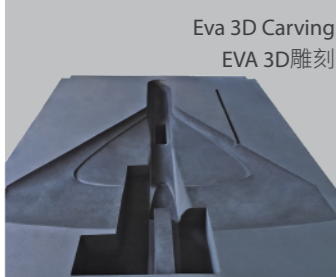

EPE Product Type

EPE 產品類型

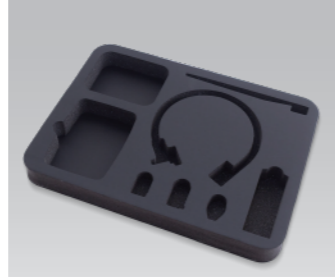
 Thickness 厚度 0.5-10 mm EPE Paper / EPE布(舒美布)	 ID 內徑 4-100 mm OD 外徑 14-150 mm EPE Tube / EPE管	 EPE Bag / EPE袋	 Thickness 厚度 10mm以上 EPE Board / EPE板
 EPE L type-U type-Stick / EPE L型-U型-實心棒	 EPE Hot Paste / EPE熱貼	 EPE CNC Engraving / EPE CNC雕刻	 EPE Punching / EPE沖型

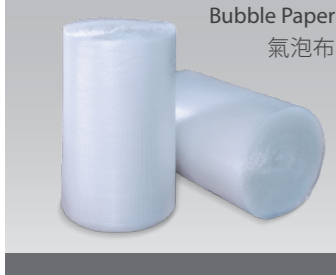
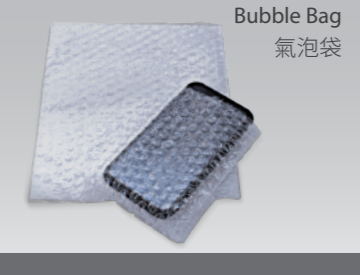
Other Materials

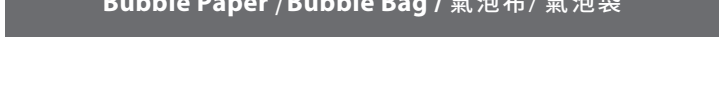
其他材料

 Eva 3D Carving EVA 3D雕刻	 Eva Hot Pressing EVA 熱壓	 Eva Punching EVA 沖型	 PU Foam / PU泡棉
 EVA			
 Bubble Paper 氣泡布	 Bubble Bag 氣泡袋	 XPE Punching XPE 沖型	 XPE Vacuum Forming XPE 真空成型
 Bubble Paper / Bubble Bag / 氣泡布 / 氣泡袋			
 XPE / IXPE (Chemical / Electronic Cross-linked PE) / XPE/IXPE (化學/電子交聯PE)			

穩固品質 Stable Quality

迅速服務 Fast Service

EPE Application

EPE 產品應用

Electronic Product

電子產品

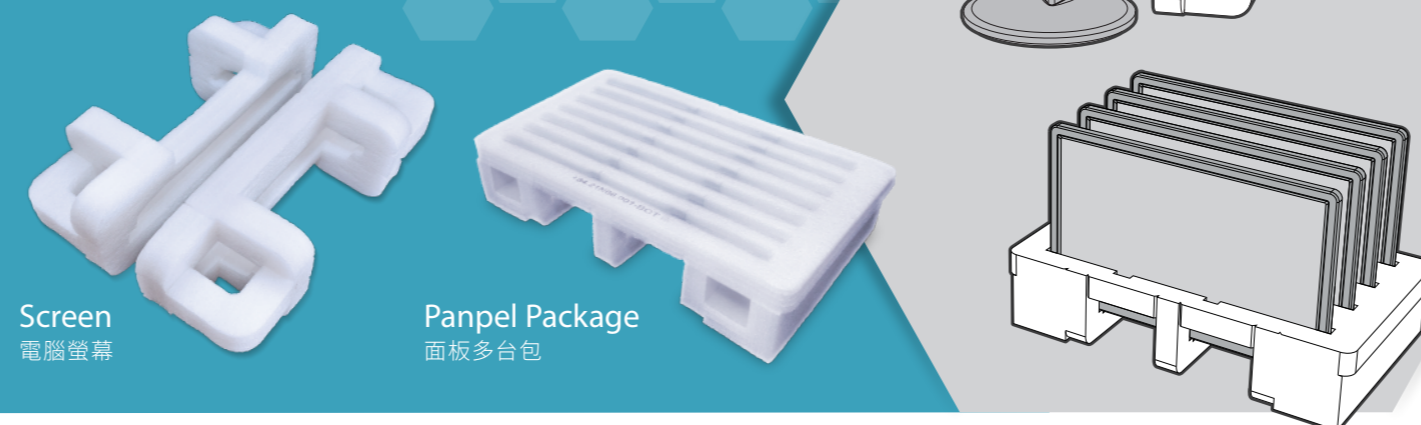

Outsourcing of Electronic Products

電子產品外包



Foam Insert Tray For Tools

手工具箱內襯



誠信團隊 Integrated Team

多方應用 Diverse Applications

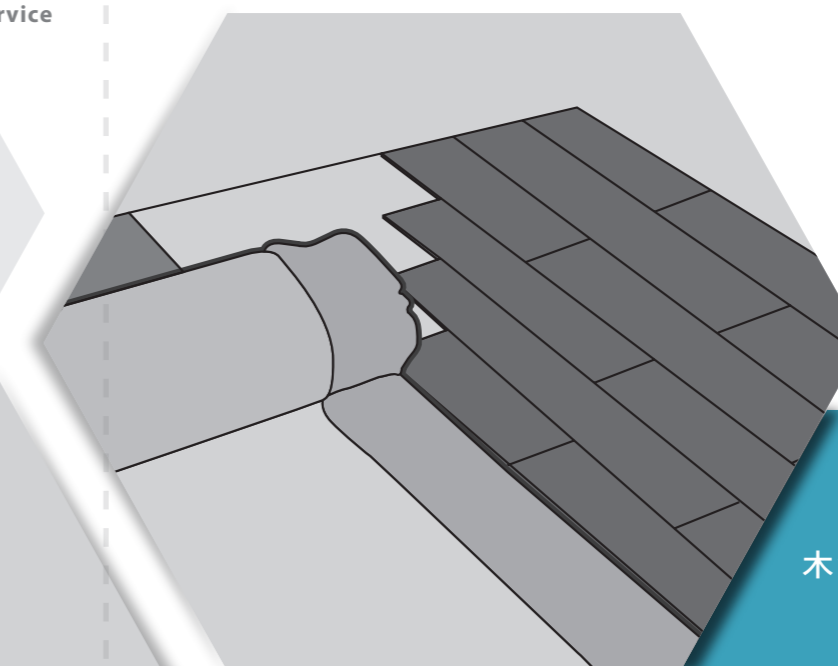

Flooring Underlay

木質地板防潮隔音墊

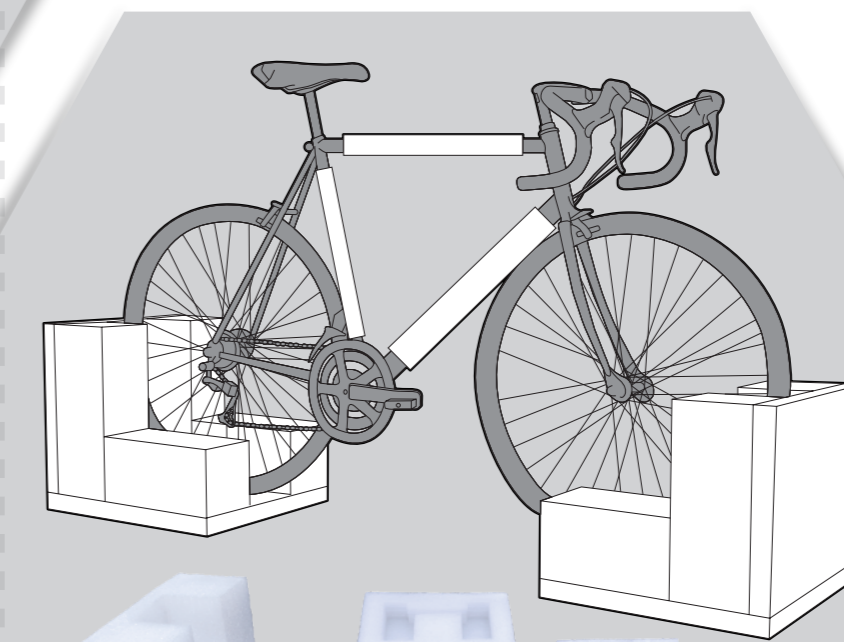

Yun-Lun offers both standardized mass production and customized services. Yun-Lun has rich cooperative development experiences with our partners from high added-value industries, such as automotive, bicycle, consumer electronics, military, public engineering, sports equipment, bag accessory and hand tools.

本公司提供客製化及制式規格大量訂製服務，擁有與汽機車、自行車、3C、國防軍用品、公共工程、運動器材、皮包五金、手工具等具備高附加價值特性的產業夥伴合作開發的經驗。

Bicycle Package

自行車整車包裝

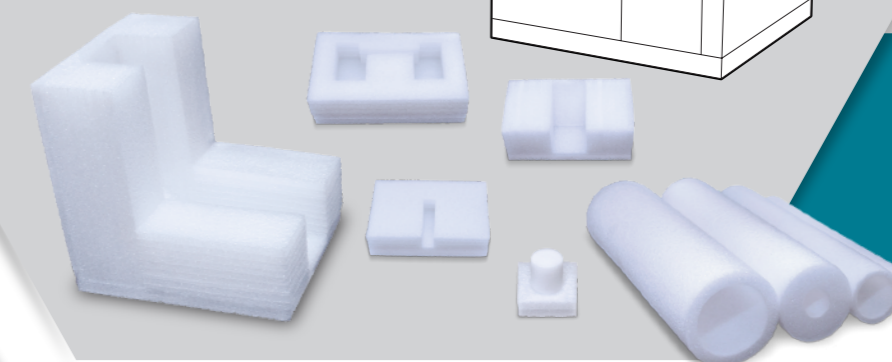

Stainless Steel Foaming Thermal Insulation Pipe

不鏽鋼管保溫材



永續經營 Sustainable Development